

F1



WITH SOLID RODS
MED GENNEMGÅENDE STÆNGER

SAMLEVEJLEDNING ASSEMBLY MANUAL

Distribuito da: Garlando srl Via Regione Piemonte, 5 Zona Ind. D1 15068 Pozzolo Formigaro (AL) ITALY



**OBS - gem denne vejledning.
Dette produkt anbefales ikke til børn under 3 år, da de små dele kan sluges eller indhaleres.**

Vedligeholdelse af dit bord

Tillykke! Du har købt et kvalitetsprodukt fra Garlando.

Dette bord er kun til indendørs brug, hvor samling og brug ligeledes skal foregå indendørs.

VIGTIGT: Når bordet er samlet fylder det mere - så vi anbefaler at bordet samles i rummet det skal stå for at undgå problemer med at få det igennem døre og andet.

For at sikre lang levetid på dit bord - finder du herunder nogle relevante tips:
Dit bord er produceret til indendørs brug - så det må ikke efterlades udendørs.
Regn, sne og høj luftfugtighed kan skade materialerne.
Ydermere kan længere tid i sol resultere i misfarvning af materialerne.

Rengør dit bord jævnligt.

Normal rengøring klares med en hårdt opvredet fugtig klud.

For grundigere rengøring kan du bruge almindelig sulfo som ikke indeholder voks eller skurepulver.

Garlando's stænger kræver ikke rengøring.

Ønsker du derimod at forbedre stængerne kan disse smøres med kvalitets silikone spray.

Vi fraråder al brug af vegetalsk olie eller anden form for olie, da du risikerer at tiltrække skidt.

Garlando accepterer ikke reklamationer, hvor problemet er resulteret af at ovenstående instruktioner ikke er fulgt.

WARNING, READ AND KEEP

**This product is not suitable for use by children under 3 years.
Small balls might be swallowed or inhaled.**

Care and maintenance instructions for your table

Congratulations! You have bought a first quality table.

It is an indoor table: please assemble it and use it indoors only.













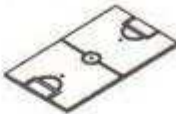









IMPORTANT: Once assembled your table is quite wide and may not fit through your doors. For this reason you should assemble it in the room you intend it to be used. Should you wish to move your table to another room, it might be necessary to remove its legs.

In order to ensure its long life and continued playing appeal, we recommend that you follow the simple instructions below:

1. Your table has been manufactured for indoor playing: do not leave it outdoors. Rain, snow and high humidity may damage its materials. Prolonged exposure to the sun is to be avoided too, due to its ultraviolet effects which will ruin the colours.
2. Clean your table periodically. It is sufficient to wipe its surfaces using a damp cloth. For a deeper cleaning you can use any household detergent which does not contain wax or abrasives. Should you wish to furtherly improve bars smoothness, only employ a good quality silicone spray. Please be careful not to use any vegetal or any other type of grease or you run the risk of attracting dirt.

Garlando does not accept any responsibility for damages resulting from disregarding these instructions.

Komponenter / Components

<p>P1 2 St. / Pcs.</p>  <p>Lang side Side panel</p>	<p>P2 2 St. / Pcs.</p>  <p>Kort side End panel</p>	<p>P3 1 St. / Pcs.</p>  <p>Spilleflade Play field</p>	<p>P4 4 St. / Pcs.</p>  <p>Ben Legs</p>
<p>P5 2 St. / Pcs.</p>  <p>Støttebjælke Support brace</p>	<p>P6 8 St. / Pcs.</p>  <p>Håndtag Handle</p>	<p>P7 16 St. / Pcs.</p>  <p>Gummi buffer Shock absorber</p>	<p>P8 2 / St. / Pcs.</p>  <p>Tæller Score counter</p>
<p>P12 4 St. / Pcs.</p>  <p>Stillefødder Leg levellers</p>	<p>R1 1+1 St. / Pcs.</p>  <p>Stang m/ 4 spillere 4 Players rod</p>	<p>R2 2+2 St. / Pcs.</p>  <p>Stang m/ 3 spillere 3 Players rod</p>	<p>R3 1+1 St. / Pcs.</p>  <p>Stang m/ 1 spiller 1 Players rod</p>
<p>H1 2 St. / Pcs.</p>  <p>Støttestang Support rod</p>	<p>H2 24 St. / Pcs.</p>  <p>Bolt Bolt</p>	<p>H3 24 St. / Pcs.</p>  <p>Skive m/ stort hul Washer with big hole</p>	<p>H6 4 St. / Pcs.</p>  <p>Møtrik Nut</p>
<p>H7 4 St. / Pcs.</p>  <p>Skrue Screw</p>	<p>H8 32 St. / Pcs.</p>  <p>Plastik skive Plastic Washer</p>	<p>H9 8 St. / Pcs.</p>  <p>Plastik endestykke for stang Plastic push for solid rod</p>	
<p>A1 2 St. / Pcs.</p>  <p>Fodbold Ball</p>	<p>A2 1+1 St. / Pcs.</p>  <p>Unbrakonøgle Allen</p>	<p>A3 1 St. / Pcs.</p>  <p>Svensknøgle Wrench</p>	

STEP 1

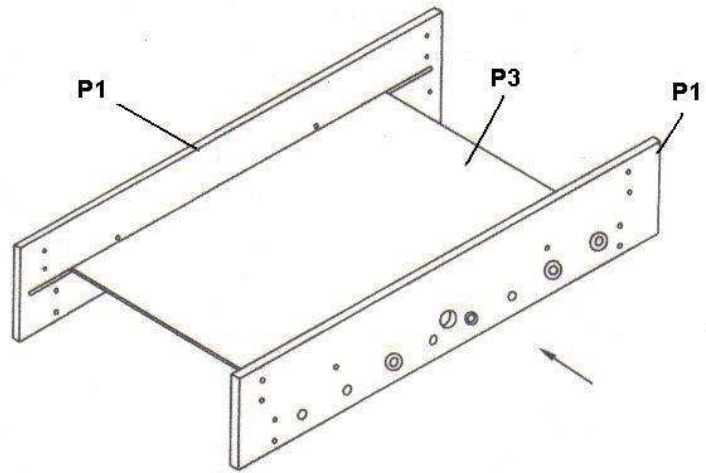

STEP 2

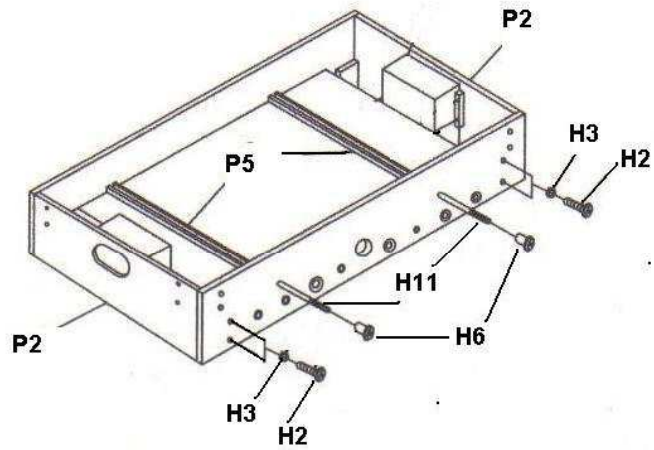

STEP 3

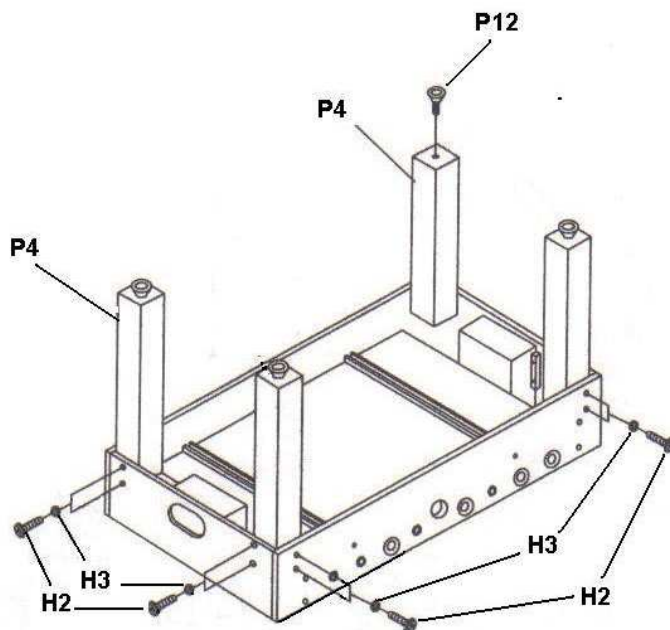

STEP 4

Håndtags side
Handle side

Hul / Hole

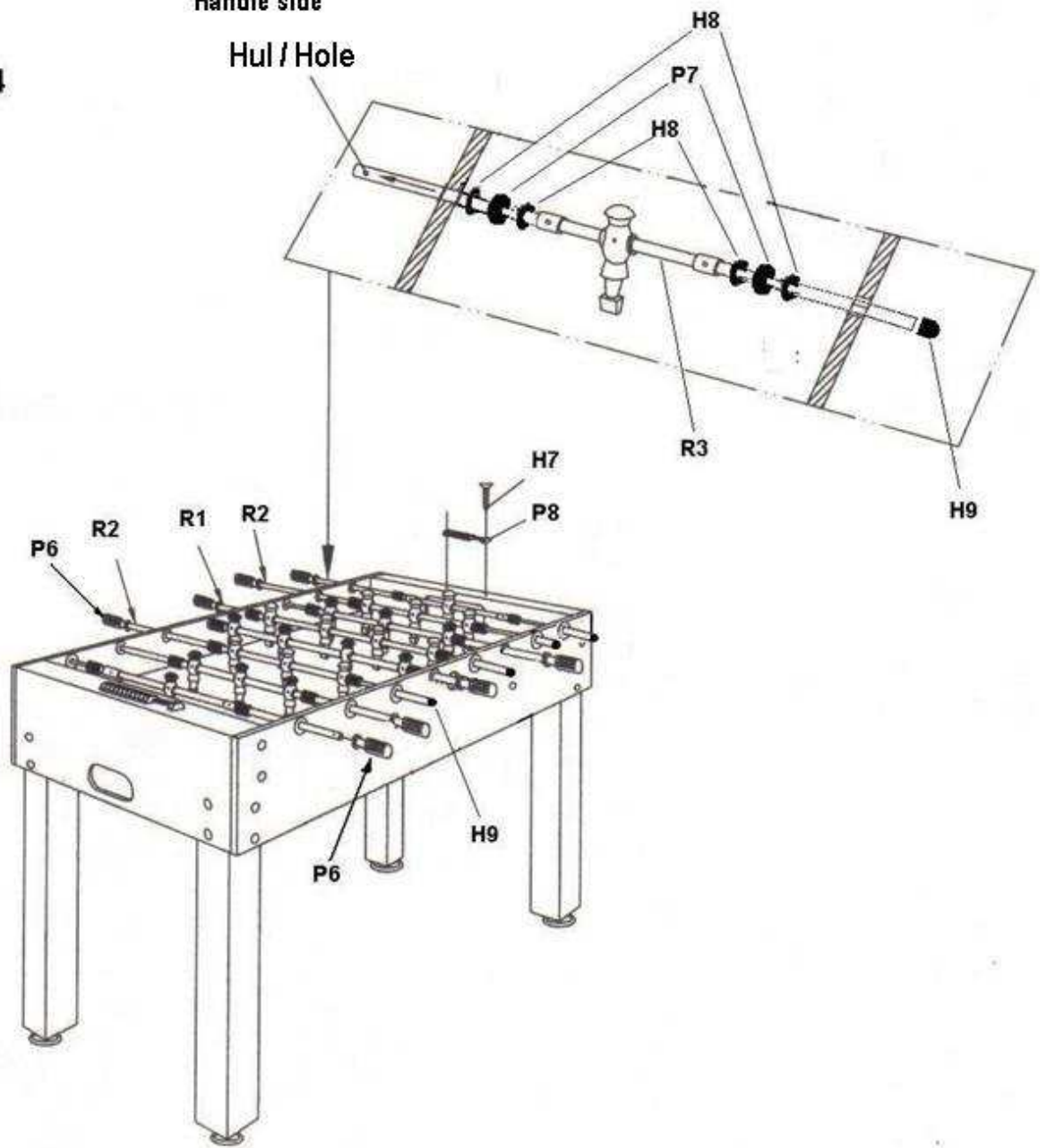

Stænger position / Rod position

Bordet er udstyret med 4 stænger til hvert hold:

- Målmand - stang m/ 1 spiller: placeres i hver ende af bordet - position A.
- Forsvar - stang m/2 spillere: placeres foran målmændene af samme farve - position B.
- Angreb - stang m/ 3 spillere: placeres foran modstanderens forsvar - position D.
- Midtbane - stang m/ 5 spillere: placeres på egen banehalvdel i midten med ansigten mod modstanderens midtbanespillere - position C

The football-table is equipped with 4 rods for each team:

- Goalkeeper/1 player-rod: at the end of the playfield. Position A
- Defence/2 player-rod: in front of the same colour goalkeeper. Position B
- Mid-fielder/5 player-rod: in the middle of the playing field, in front of the 5-player rod of the opposite colour. Position C
- Forward/3 player-rod: in front of the 2 player-rod of the opposite colour. For example: the blue forward rod faces the red defence rod. Position D

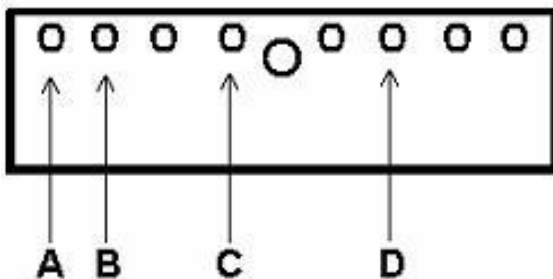

Start med at isætte målmændene og derefter alle andre stænger af samme farve ud fra ovenstående vejledning. Det samme gøres for modstander holdet.

Start by placing the 1 player-rod and then all the others of the same colour following the above mentioned positions. Do the same for the other colour team.

Oversigt over slutresultat - Diagram of final assembly

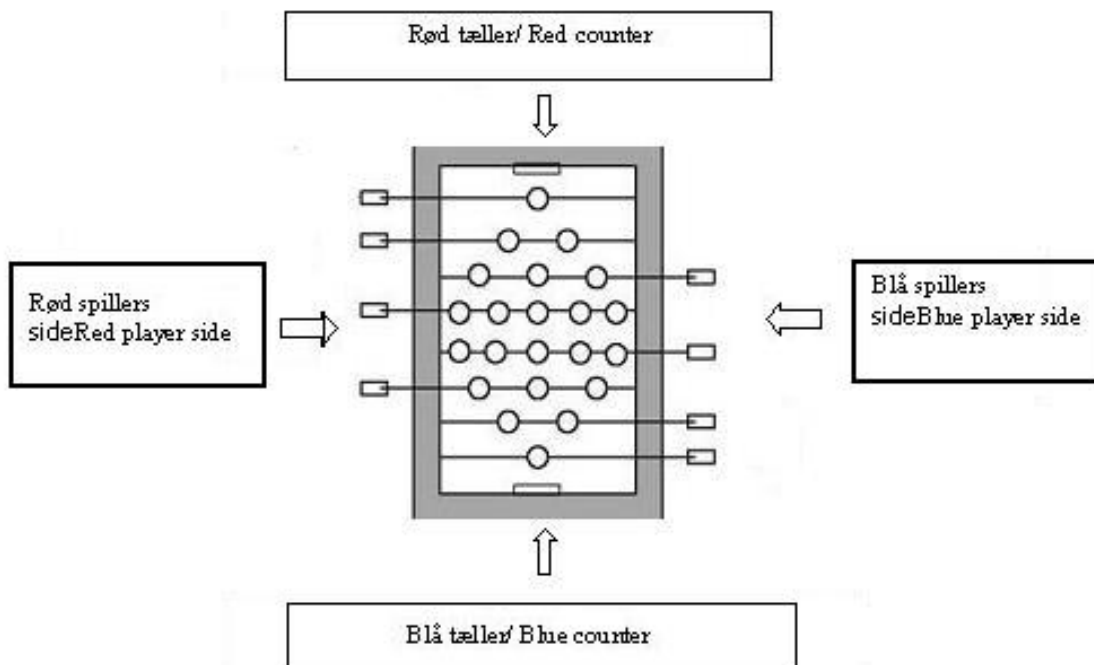

DEMOLIZIONE DEL CALCIOTALLA E SMALTIMENTO SOSTANZE NOCIVE

Demolizione:

Il calciotalla non richiede particolari cure per la demolizione non avendo parti costruttive realizzate con materiali pericolosi.

I materiali con cui è costruito sono:

Legno, MDF, acciaio, alluminio, ABS, PP (moplen), PE, PVC, Vetro.

In particolare questi materiali sono presenti in:

Struttura: Legno, MDF, Acciaio.

Gambe: Legno, Acciaio

Campo gioco: Legno, Vetro.

Aste: acciaio, PP (moplen).

Accessori: ABS, PE, PVC.

Rifiniture: Alluminio, ABS.

Durante la fase di demolizione si consiglia la suddivisione per tipologia dei materiali che lo costituiscono e il loro smaltimento presso centri di raccolta autorizzati che effettuano il recupero/riutilizzo degli stessi.

All'interno del calciotalla, possono essere presenti anche delle schede e componenti elettronici e tubi fluorescenti.

Smaltimento delle sostanze nocive

Il calciotalla non produce sostanze nocive.

I tubi fluorescenti e i componenti elettronici, presenti sulle schede di controllo possono contenere delle sostanze che li rendono pericolosi, questi particolari devono quindi essere conferiti ad un idoneo centro di smaltimento o recupero autorizzato.

VERNICHTUNG DES FUßBALLTISCHES UND ENTSORGUNG DER SCHADSTOFFE

Vernichtung:

Der Fußballtisch benötigt keine besondere Pflege für die Vernichtung, denn er hat keine mit gefährlichen Materialien produzierten Bestandteile. Die Fußballtischmaterialien sind:

Holz, MDF, Stahl, Aluminium, ABS, PP (moplen), PE, PVC, Glas.

Diese Materialien sind anwesend in den folgenden Teilen:

Gerüst: Holz, MDF, Stahl.

Beine: Holz, Stahl

Spielfeld: Holz, Glas.

Stangen: Stahl, PP (moplen).

Zubehörteile: ABS, PE, PVC.

Verzierung: Aluminium, ABS.

Während der Vernichtung des Fußballtisches empfehlen wir die Materialunterteilung und die Entsorgung der Materialien bei berechtigten Sammlungszentren für ihr Recycling.

Der Fußballtisch kann Platinen, elektronische Bestandteile und fluoreszierende Röhren enthalten.

Vernichtung der Schadstoffe

Der Fußballtisch produziert keine Schadstoffe.

Die fluoreszierenden Röhren und die elektronischen Bestandteile auf der Platinen können gefährliche Stoffe enthalten, deshalb müssen diese Bestandteile in ein berechtigtes Entsorgungs- und Recyclingzentrum geliefert werden.

FOOTBALL-TABLE DEMOLITION AND HARMFUL MATERIAL REMOVAL

Demolition:

The football table doesn't require any particular care for the demolition since it doesn't have any parts produced with dangerous materials. The materials are:

Wood, MDF, steel, aluminium, ABS, PP (moplen), PE, PVC, Glass.

These materials are present in the following parts:

Frame: Wood, MDF, Steel.

Legs: Wood, Steel.

Playfield: Wood, Glass.

Rods: Steel, PP (moplen).

Accessories: ABS, PE, PVC.

Finishing: Aluminium, ABS.

During football-table demolition we suggest the sharing of the different materials and their removal in authorized collection centre for their recycling.

The football-table may contain cards, electronic components and fluorescent pipes.

Removal of harmful materials

The football-table doesn't produce any harmful substances.

The fluorescent pipes and the electronic components on the control cards may contain dangerous materials and therefore these parts must be collected by an authorized removal and recycling centre.